



# Accessori

/ 07

ACCESSORI

# TE12

Terminale in alluminio 12x55

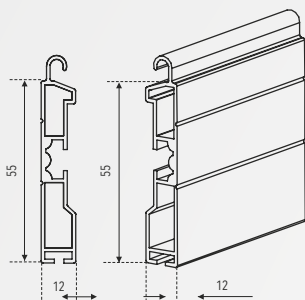

ARTICOLO	TIPOLOGIA	DESCRIZIONE	Um
<b>TE12BAGR</b>	barre da 6,50 m	in alluminio estruso 12x55	ml
<b>TE12BA</b>	barre da 6,50 m	in alluminio estruso 12x55	ml
<b>TE12SM</b>	su misura	in alluminio estruso 12x55	ml

# T112 REVERSE

Terminale in alluminio 12,5x62

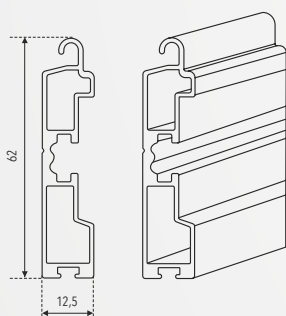

ARTICOLO	TIPOLOGIA	DESCRIZIONE	Um
<b>T112BAGR</b>	barre da 6,50 m	in alluminio estruso 12x55	ml
<b>T112BA</b>	barre da 6,50 m	in alluminio estruso 12x55	ml
<b>T112SM</b>	su misura	in alluminio estruso 12x55	ml

In varie colorazioni, adatti per avvolgibili di alluminio e acciaio.

COLORI	RAL	TERMINALI IN ALLUMINIO 9x55
<b>OSSIDATI</b>		
ARGENTO OSSIDATO	-	•
BRONZO OSSIDATO	-	•
ELETTROCOLORE NERO	-	•
<b>TINTA UNITA</b>		
AVORIO	1013	•
AVORIO	1015	•
BEIGE	1019	•
BIANCO	9010	•
BIANCO PAPIRO	9002	•
BLU	5015	•
BLU GENZIANA	5005	•
CARTA DA ZUCCHERO	-	•
GIALLO OCRA	-	•
GRIGIO ARGENTO	7001	•
GRIGIO CHIARO	7004	•
GRIGIO	7006	•
GRIGIO PRACAL	7016	•
GRIGIO	7021	•
GRIGIO 35	7035	•
GRIGIO PLATINO	7036	•
GRIGIO POLVERE	7037	•
GRIGIO QUARZO	7039	•
GRIGIO SETA	7044	•
GRIGIO TELE4	7047	•
GRIGIO	9007	•
GRIGIO AGATA	-	•
MARRONE 25	8003	•
MARRONE	8017	•
ROSSO VIVO	3003	•
ROSSO PORPORA	3004	•
ROSSO VINO	3005	•
ROSSO MATTONE	3009	•
ROSSO RUGGINE	-	•
SABBIA	-	•
SALMONE	-	•
SEPPIA	-	•
TESTA DI MORO	8019	•
VERDE SCURO	6005	•
VERDE OLIVA	6011	•
VERDE PISELLO	6021	•
VERDE56	6024	•
VERDE ACQUAMARINA	-	•
VERDE MENTA	-	•
<b>RAFFAELLO</b>		
GRIGIO RAFFAELLO	-	•
ROSSO RAFFAELLO	-	•
TDM RAFFAELLO	-	•
VERDE RAFFAELLO	-	•

# TE09

Terminale in alluminio 9x55

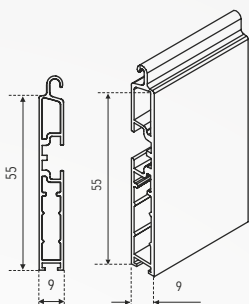

ARTICOLO	TIPOLOGIA	DESCRIZIONE	Um
<b>TE09BAGR</b>	barre da 6,50 m	in alluminio estruso 9x55	ml
<b>TE09BA</b>	barre da 6,50 m	in alluminio estruso 9x55	ml
<b>TE09SM</b>	su misura	in alluminio estruso 9x55	ml

# TI09 REVERSE

Terminale in alluminio 7,4x55

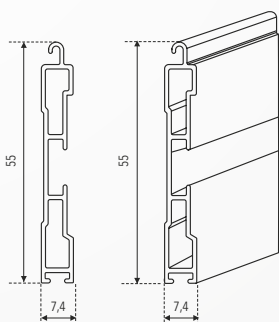

ARTICOLO	TIPOLOGIA	DESCRIZIONE	Um
<b>TI09BAGR</b>	barre da 6,50 m	in alluminio estruso 12x55	ml
<b>TI09BA</b>	barre da 6,50 m	in alluminio estruso 12x55	ml
<b>TI09SM</b>	su misura	in alluminio estruso 12x55	ml

In varie colorazioni, adatti per avvolgibili di alluminio e acciaio.

COLORI	RAL	TERMINALI IN ALLUMINIO 9x55
<b>OSSIDATI</b>		
ARGENTO OSSIDATO	-	•
BRONZO OSSIDATO	-	•
ELETTROCOLORE NERO	-	•
<b>TINTA UNITA</b>		
AVORIO	1013	•
AVORIO	1015	•
BEIGE	1019	•
BIANCO	9010	•
BIANCO PAPIRO	9002	•
BLU	5015	•
BLU GENZIANA	5005	•
CARTA DA ZUCCHERO	-	•
GIALLO OCRA	-	•
GRIGIO ARGENTO	7001	•
GRIGIO CHIARO	7004	•
GRIGIO	7006	•
GRIGIO PRACAL	7016	•
GRIGIO	7021	•
GRIGIO 35	7035	•
GRIGIO PLATINO	7036	•
GRIGIO POLVERE	7037	•
GRIGIO QUARZO	7039	•
GRIGIO SETA	7044	•
GRIGIO TELE4	7047	•
GRIGIO	9007	•
GRIGIO AGATA	-	•
MARRONE 25	8003	•
MARRONE	8017	•
ROSSO VIVO	3003	•
ROSSO PORPORA	3004	•
ROSSO VINO	3005	•
ROSSO MATTONE	3009	•
ROSSO RUGGINE	-	•
SABBIA	-	•
SALMONE	-	•
SEPPIA	-	•
TESTA DI MORO	8019	•
VERDE SCURO	6005	•
VERDE OLIVA	6011	•
VERDE PISELLO	6021	•
VERDE56	6024	•
VERDE ACQUAMARINA	-	•
VERDE MENTA	-	•
<b>RAFFAELLO</b>		
GRIGIO RAFFAELLO	-	•
ROSSO RAFFAELLO	-	•
TDM RAFFAELLO	-	•
VERDE RAFFAELLO	-	•

# COLORI TERMINALI ALLUMINIO

TERMINALI IN PVC  
ACCESSORI

## COLORI RAL

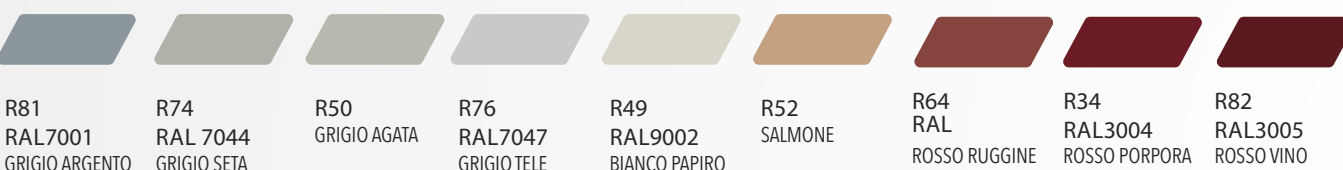
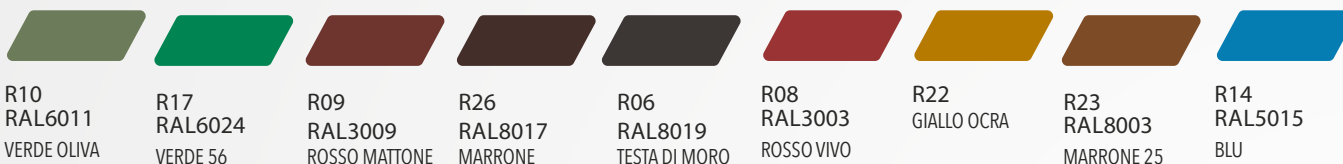
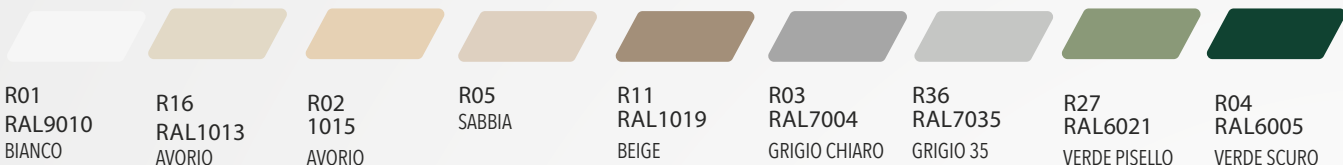

## COLORI OSSIDATI

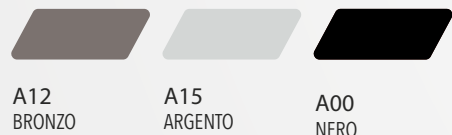
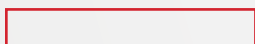









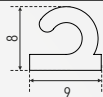

## COLORI RAFFELLO



A19 GRIGIO RAFFAELLO  
A18 VERDE RAFFAELLO  
A20 ROSSO RAFFAELLO  
A21 TESTA DI MORO RAFFELLO

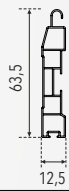

# TERPVC

## Terminali in pvc

ARTICOLO	TIPOLOGIA	DESCRIZIONE	CONFEZIONE	DISEGNO	Um	
<b>TERPVCDUO</b>	barre da 5 m	in PVC rigido	25 barre			ml
per avvolgibili in Pvc modello Vega e avvolgibili in alluminio e acciaio						
<b>TERPVCPLA</b>	barre da 5 m	in PVC super	25 barre			ml
per avvolgibili in Pvc modello Vega - disponibile in tutti i colori PVC						
<b>TERPVCRIIG</b>	rotoli da 150 m	in PVC rigido				ml
per avvolgibili in alluminio e acciaio						
<b>TERPVCBA</b>		Terminale in PVC Maxi				barre
<b>TERPVCSM</b>		Terminale in PVC Maxi				su misura
<b>TERPVC PAN</b>		Terminale in PVC stecca Panoramica				ml
<b>TERPVC PAE</b>		Battuta in gomma per terminale estruso Panoramica				ml

# TERFER

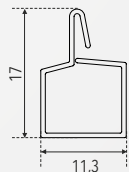
## Terminali in ferro

ARTICOLO	TIPOLOGIA	DESCRIZIONE	DISEGNO	Um	
<b>TERFERZIN</b>	barre 6m	in ferro zincato			ml
<b>TERFERZINSM</b>	su misura	in ferro zincato		ml	

per avvolgibili in Pvc modello Vega M13

# GU3541

Guida in alluminio

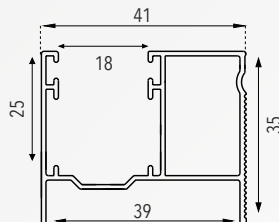

ARTICOLO	TIPOLOGIA	DESCRIZIONE	SPAZZOLINO	Um
GU3541BA	Barre da 6,50m	Guida in alluminio estruso 35x41	-	ml
GU3541SM	Barre su misura	Guida in alluminio estruso 35x41	•	ml

GU3541 dimensioni 35x41 mm

# GU3245

Guida in alluminio

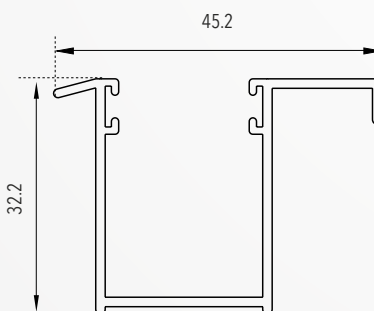
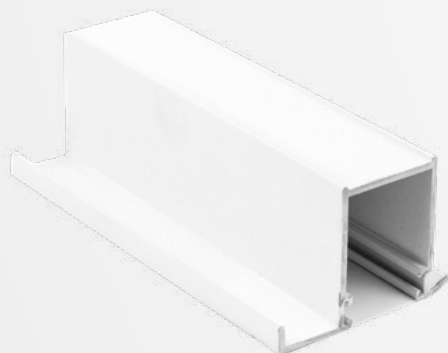

ARTICOLO	TIPOLOGIA	DESCRIZIONE	SPAZZOLINO	Um
GU3245BA	Barre da 6,50m	Guida per alluminio estruso 32x45	-	ml
GU3245SM	Barre Su misura	Guida per alluminio estruso 32x45	•	ml

**Legenda:**

- DISPONIBILE
- NON DISPONIBILE

GU3245 dimensioni 45,2x32,2 mm

# GU2887

Guida in alluminio estruso

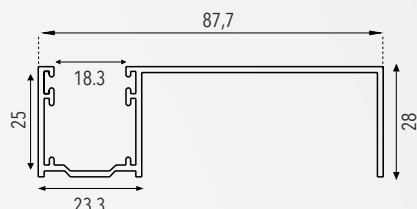
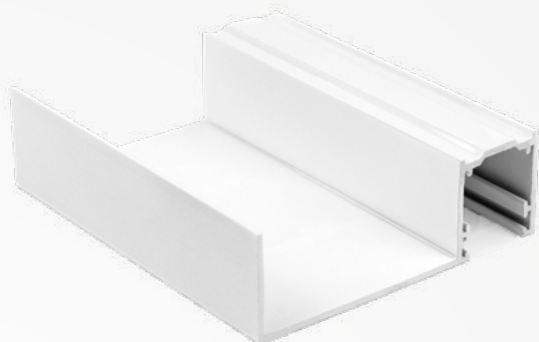

ARTICOLO	TIPOLOGIA	DESCRIZIONE	SPAZZOLINO	Um
<b>GU2887BA</b>	Barre da 6,50m	Guida in alluminio estruso 28x87	-	ml
<b>GU2887SM</b>	Barre su misura	Guida in alluminio estruso 28x87	•	ml

**GU2887** dimensioni 28x87,7 mm

# GU2814

Guida in alluminio estruso

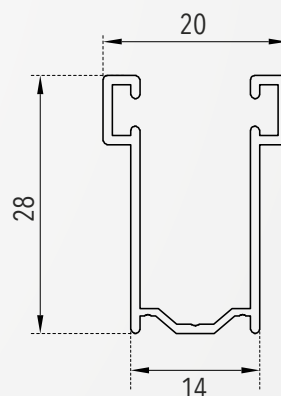

ARTICOLO	TIPOLOGIA	DESCRIZIONE	SPAZZOLINO	Um
<b>GU2814BA</b>	Barre da 6,50m	Guida in alluminio estruso 28x14	-	ml
<b>GU2814SM</b>	Barre su misura	Guida in alluminio estruso 28x14	•	ml

**Legenda:**

- DISPONIBILE
- NON DISPONIBILE

**GU2814** dimensioni 28x14 mm



# GU2716

Guide in alluminio

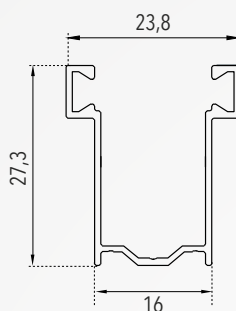

ARTICOLO	TIPOLOGIA	DESCRIZIONE	SPAZZOLINO	Um
GU2716BA	barre da 6,50 m	in alluminio estruso 27,3x16	-	ml
GU2716SM	su misura	in alluminio estruso 27,3x16	•	ml

GU2716 dimensioni 27,3x16 mm

# GU2520

Guide in alluminio

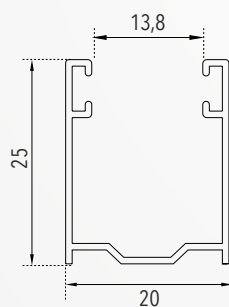
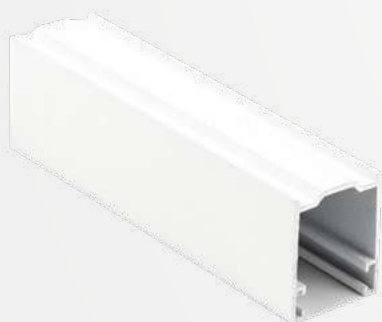

ARTICOLO	TIPOLOGIA	DESCRIZIONE	SPAZZOLINO	Um
GU2520BA	barre da 6,50 m	in alluminio estruso 25x20	-	ml
GU2520SM	su misura	in alluminio estruso 25x20	•	ml

GU2520 dimensioni 25x20 mm

**Legenda:**

- DISPONIBILE
- NON DISPONIBILE

# GU3025

Guide in alluminio

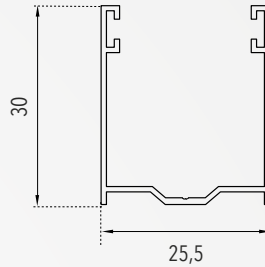

ARTICOLO	TIPOLOGIA	DESCRIZIONE	SPAZZOLINO	Um
<b>GU3025BA</b>	barre da 6,50 m	in alluminio estruso 30x25,5	-	ml
<b>GU3025SM</b>	su misura	in alluminio estruso 30x25,5	•	ml

**GU3025** dimensioni 30x25,5 mm

# GU2817

Guide in alluminio estruso

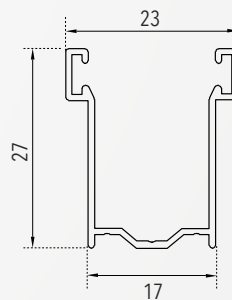

ARTICOLO	TIPOLOGIA	DESCRIZIONE	SPAZZOLINO	Um
<b>GU2817BA</b>	barre da 6,50 m	in alluminio estruso 27x17	-	ml
<b>GU2817SM</b>	su misura	in alluminio estruso 27x17	•	ml

**GU2817** dimensioni 27x17 mm

**Legenda:**

- DISPONIBILE
- NON DISPONIBILE

# GU3019

Guide in alluminio

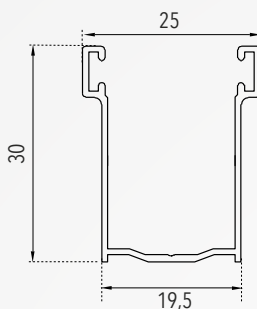

ARTICOLO	TIPOLOGIA	DESCRIZIONE	SPAZZOLINO	Um
GU3019BA	barre da 6,50 m	in alluminio estruso 30x19,5	-	ml
GU3019SM	su misura	in alluminio estruso 30x19,5	•	ml

GU3019 dimensioni 30x19,5 mm

# GU4025

Guide in alluminio

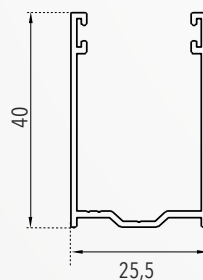
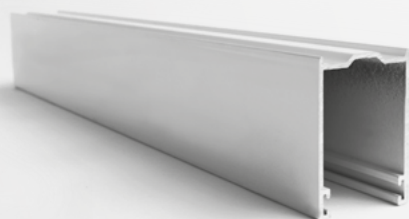

ARTICOLO	TIPOLOGIA	DESCRIZIONE	SPAZZOLINO	Um
GU4025BA	barre da 6,50 m	in alluminio estruso 40x25,5	-	ml
GU4025SM	su misura	in alluminio estruso 40x25,5	•	ml

GU4025 dimensioni 40x25,5 mm

**Legenda:**

- DISPONIBILE
- NON DISPONIBILE

# GU3116

Guide in alluminio

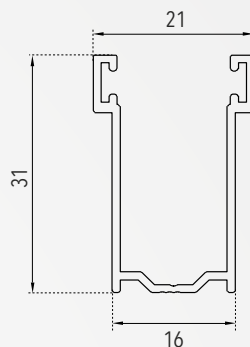

ARTICOLO	TIPOLOGIA	DESCRIZIONE	GUARNIZIONE	Um
<b>GU3116BA</b>	barre da 6,50 m	in alluminio estruso 31x16	mod.Lupin	ml
<b>GU3116SM</b>	su misura	in alluminio estruso 31x16	mod.Lupin	ml

**GU3116** dimensioni 31x16 mm

Guida 3116 per modello Lupin.

# GU6027

Guide antivento

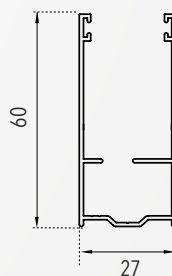

ARTICOLO	TIPOLOGIA	DESCRIZIONE	SPAZZOLINO	Um
<b>GU6025BA</b>	barre da 6,50 m	in alluminio estruso 60x27	-	ml
<b>GU6025SM</b>	su misura	in alluminio estruso 60x27	•	ml

**GU6025** dimensioni 60x27 mm

Compatibile con i profili **HD** (alta densità) in alluminio modelli Ariel, L15, C12 e E12.

**Legenda:**

- DISPONIBILE
- NON DISPONIBILE

# G85I

Guida con predisposizione per zanzariera

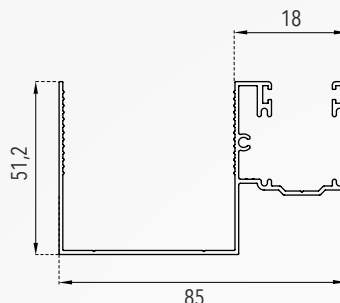
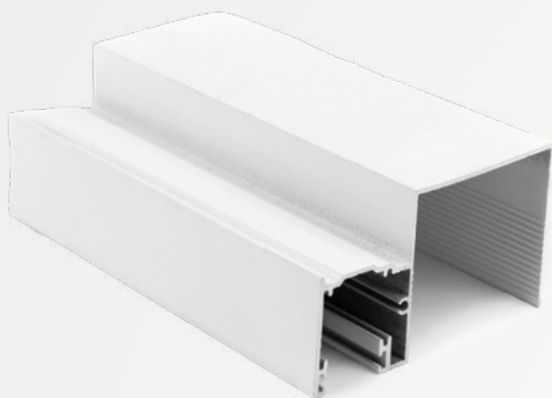

ARTICOLO	TIPOLOGIA	DESCRIZIONE	SPAZZOLINO	Um
G85IBA	a barre	in alluminio estruso 51,20x85	-	ml
G85ISM	su misura	in alluminio estruso 51,20x85	•	ml

G85I dimensioni 85 x 51,2 mm

**Legenda:**

- DISPONIBILE
- NON DISPONIBILE

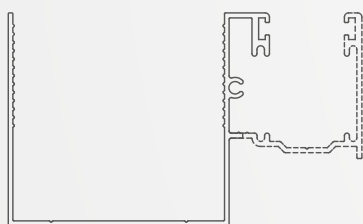

Guida in alluminio estruso 85 x 51,20 in barre da 6,5 metri



TAPGU85I (DX e SX) Profilo tappo per guida predisposizione tapparella da 85	UM pz	TAPINVGU85I (DX e SX) Inviti guida + tappi guida: TAPINV85IDX TAPINV85ISX	UM pz	C85IBA Carter per guida G851 a barre	UM ml	C85ISM Carter per guida G851 su misura	UM ml
--	----------	--	----------	---	----------	---	----------

# G75I

Guida con predisposizione per zanzariera

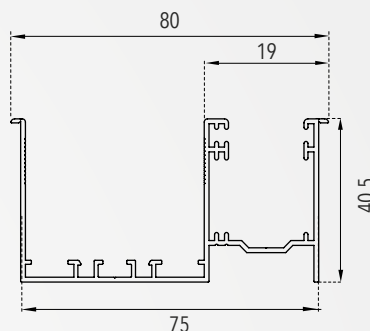
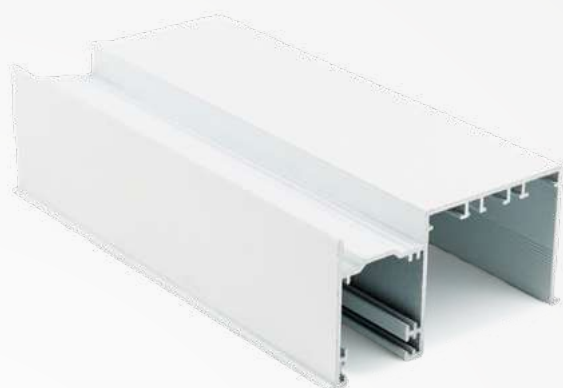

ARTICOLO	TIPOLOGIA	DESCRIZIONE	SPAZZOLINO	Um
G75IBA	a barre	in alluminio estruso 40,5x75	-	ml
G75ISM	su misura	in alluminio estruso 40,5x75	•	ml

G75I dimensioni 75 x 40,5 mm

**Legenda:**

- DISPONIBILE
- NON DISPONIBILE

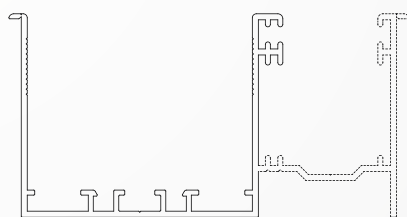

Guida in alluminio estruso 75 x 40,5 in barre da 6,5 metri



**TAPGU75I**  
 Profilo tappo per guida predisposizione incasso da 75

UM  
pz

**TAPINVGU75I**  
 Invito guida + tappo guida:  
 TAPINVGU75DX  
 TAPINVGU75SX

UM  
pz

**C75IBA**  
 Carter per guida G75I a barre

UM  
ml

**C75ISM**  
 Carter per guida G75I su misura

UM  
ml

# GU3026

Guida in alluminio

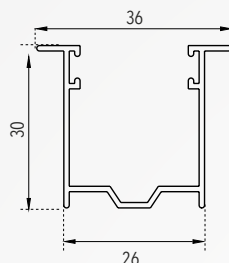
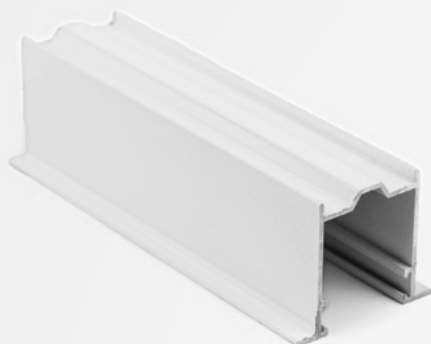

ARTICOLO	TIPOLOGIA	DESCRIZIONE	SPAZZOLINO	Um
GU3026BA	Barre da 6,50m	Guida per alluminio 30x26	-	ml
GU3026SM	Barre su misura	Guida alluminio estruso 20x26	•	ml

GU3026 dimensioni 30x26 mm

# GU3816

Guida doppio spazzolino

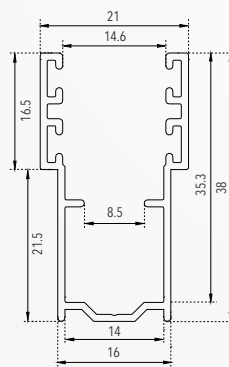

ARTICOLO	TIPOLOGIA	DESCRIZIONE	SPAZZOLINO	Um
GU3816BA	doppio spazzolino	Guida doppio spazzolino	Barre da 6.50	ml
GU3816SM	doppio spazzolino	Guida doppio spazzolino	Su misura	ml

Legenda:

- DISPONIBILE
- NON DISPONIBILE

GU3816 dimensioni 38x16 mm

# GU4340

Guida in alluminio

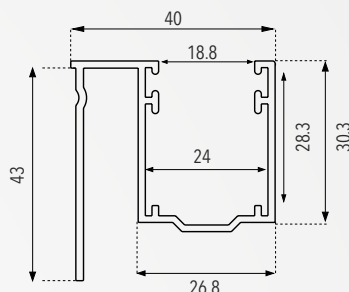
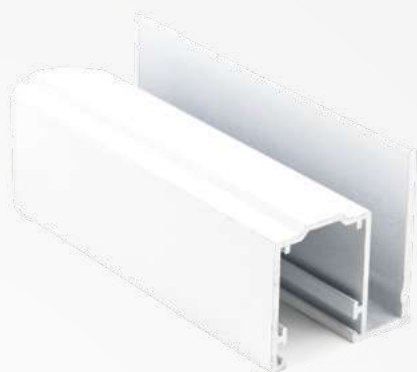

ARTICOLO	TIPOLOGIA	DESCRIZIONE	SPAZZOLINO	Um
<b>GU4340BA</b>	Barre da 6,50m	Guida per alluminio 43x43	-	ml
<b>GU4340SM</b>	Barre su misura	Guida per alluminio 43x43	•	ml

**Legenda:**

- DISPONIBILE
- NON DISPONIBILE







**GU4340** dimensioni 43x40 mm

CODICE PROFILO	GUIDE IN ALLUMINIO								
	PROFILO GREZZO	COLORI OSSIDATI			COLORI RAL				
		GRE	ARGENTO A15	BRONZO A12	NERO A00	RAL 9010 A01	RAL 1013 A16	RAL6005 A04	RAL8017 A26
GU3025	•	•	•	•	•	•	•	•	•
GU2817	•	•	•	•	•	•	•	•	•
GU3019	•	•	•	•	•	•	•	•	•
GU4025	•	•	•	•	•	•	•	•	•
GU6027	•	•	•	•	•	•	•	•	•
GU3026	•	•	•	•	•	•	•	•	•
GU4340	•	•	•	•	•	•	•	•	•
GU3541	•	•	•	•	•	•	•	•	•
GU3245	•	•	•	•	•	•	•	•	•
GU2887	•	•	•	•	•	•	•	•	•
GU3816	•	•	•	•	•	•	•	•	•
GU2814	•	•	•	•	•	•	•	•	•
GU2716	•	•	•	•	•	•	•	•	•
GU2520	•	•	•	•	•	•	•	•	•
GU3116	•	•	•	•	•	•	•	•	•
G85I	•	•	•	•	•	•	•	•	•
G75I	•	•	•	•	•	•	•	•	•
GU5322	•				•	•			•
GU80B	•				•	•			•
GU7527	•				•	•			•









# TAPPI LATERALI

Antiscivolo

ARTICOLO	DESCRIZIONE	DISEGNO	UM
TAPLATL08P	Tappo laterale profilo L08P piatto		Pz
TAPLAT37	Tappo laterale da 37 mm per avvolgibili L08		Pz
TAPLAT41	Tappo laterale per avvolgibili in acciaio C09		Pz
TAPLAT45	Tappo laterale da 45 mm per avvolgibili L09		Pz
TAPLAT45D	Tappo laterale da 45 mm per avvolgibili alta densità L09 + C09		Pz
TAPLAT55UN	Tappo laterale da 55 mm per avvolgibili L14 e L15		Pz
TAPLAT55D	Tappo laterale ad avvitare per profili ad alta densità L15		Pz
TAPLATL16	Tappo laterale per avvolgibile in alluminio modello Ariel e Zazà		Pz
TAPLATL16AD	Tappo laterale per avvolgibile in alluminio modello Ariel e Zazà		Pz
TAPLATAVD	Tappo laterale Antivento Destro per avvolgibile Alta Densità		Pz
TAPLATAVS	Tappo laterale Antivento Sinistro per avvolgibile Alta Densità		Pz
TAPLAT55SS	Tappo laterale a scarpetta sinistro per avvolgibile L15		Pz
TAPLAT55SD	Tappo laterale a scarpetta destro per avvolgibile L15		Pz
TAPLATBIC	Tappo laterale antiscivolo per avvolgibile Bicolore		Pz
ROSTO60E12	Rinforzo antivento per estruso		Pz

# TAPPI LATERALI

Antiscivolo per alluminio

ARTICOLO	DESCRIZIONE	DISEGNO	UM
TAPLATE09	Tappo laterale per profilo Estruso E09 (Dx + Sx)		Pz
TAPLATE11DX	Tappo laterale destro per profilo Estruso E11		Pz
TAPLATE11SX	Tappo laterale sinistro per profilo Estruso E11		
TAPLATE13DX	Tappo laterale destro per profilo Estruso E13		
TAPLATE13SX	Tappo laterale sinistro per profilo Estruso E13		Pz
TAPLATE12DX	Tappo laterale destro per profilo Estruso E12		
TAPLATE12SX	Tappo laterale sinistro per profilo Estruso E12		
PANORAMICACOIB	Tappo laterale per modello Panoramica		Pz
TAPTE12DX	Tappo laterale per terminale TE12 dx		Pz
TAPTE12SX	Tappo laterale per terminale TE12 sx		
TAPLATPANDX	Tappo laterale terminale Panoramica dx		Pz
TAPLATPANSX	Tappo laterale terminale Panoramica sx		
TAPLATJOLDX	Tappo laterale lamella jolly Panoramica dx		Pz
TAPLATJOLSX	Tappo laterale lamella jolly Panoramica sx		

## PER PVC

ARTICOLO	DESCRIZIONE	DISEGNO	UM
TAPLAT50M13SX	Tappo laterale sinistro per avvolgibile in pvc modello Vega		Pz
TAPLAT50M13DX	Tappo laterale destro per avvolgibile in pvc modello Vega		
TAPLATMSOSX	Tappo laterale sinistro per avvolgibile in pvc Soleil		Pz
TAPLATMSODX	Tappo laterale destro per avvolgibile in pvc Soleil		
TAPARR27	Tappi d'arresto in plastica da 27 mm con vite 	 27 mm	Pz
TAPARR45	Tappi d'arresto in plastica da 45 mm con vite 	 45 mm	Pz

NB Colori disponibili: bianco, avorio, testa di moro, verde, nero, grigio, Douglas

# INVITO GUIDA UNIVERSALE A RULLO

Brevetto Pracal

ARTICOLO	DESCRIZIONE	DISEGNO	UM
INVGUIPRADX	Invito guida Universale a rullo dx		pz
INVGUIPRASX	Invito guida Universale a rullo sx		pz

## RINFORZI AD H

ARTICOLO	TIPOLOGIA	DESCRIZIONE	DISEGNO	UM
BLIA.H (*)	barre da 6 m	in ferro per avvolgibili in Pvc		ml
BLIA.HSM	su misura	in ferro per avvolgibili in Pvc		ml
per avvolgibili in Pvc modello Vega M13				
BLIA.C.FIB	4,8x4mm	Blindatura per la tapparella Soleil		ml

## GUIDE IN FERRO ZINCATO

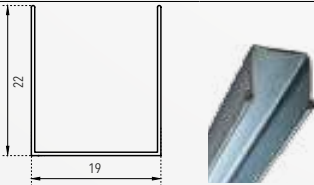
ARTICOLO	TIPOLOGIA	DESCRIZIONE	DISEGNO	UM
GF22BA	barre da 6m	in ferro zincato 22x19		ml
GF22SM	su misura	in ferro zincato 22x19		ml

(\*) Un pacco è composto da 20 barre.

# SPAZZOLINI PER GUIDE

ARTICOLO	TIPOLOGIA	DESCRIZIONE	DISEGNO	Um
<b>GUAGUI48x5</b>	4,8X5mm	Spazzolino Alto per guide in alluminio		ml
per guide GU2025, GU3025, GU3019, GU4025, GU6027				
<b>GUAGUI48x4</b>	4,8x4mm	Spazzolino basso per guide in alluminio		ml
<b>GUAGUI69x7</b>	6,9X7mm	Spazzolino alto per guide in alluminio		ml
<b>GUAGUI58x6</b>	5,8X6 mm	Spazzolino alto per guida in alluminio		ml
per guide GU3025				
<b>GUAGUI58x7</b>	5,8X7 mm	Spazzolino alto per guida in alluminio		ml

# GUARNIZIONI

ARTICOLO	TIPOLOGIA	DESCRIZIONE	DISEGNO	Um
<b>GUAE13</b>	guarnizione	per profilo in alluminio estruso E13		ml
<b>GUAGUI50x3LUP</b>	guarnizione	per guida profilo Lupin		ml
<b>GUAGUI50x5LUP</b>	guarnizione	per guida profilo Lupin		ml
<b>GUAGUI22P</b>	guarnizione	per guida profilo Panoramica		ml
<b>GUAGUI32P</b>	guarnizione	per guida profilo Panoramica		ml



# CATENACCIOLI DI SICUREZZA

Per avvolgibili in alluminio e acciaio

ARTICOLO	DESCRIZIONE	DISEGNO	UM
CATSTE000	Catenacciolo intermedio di sicurezza per stecca in alluminio e/o acciaio		Pz
CATST060	da 60 cm per stecca in alluminio e/o acciaio		
CATSTE100	da 100 cm per stecca in alluminio e/o acciaio		
CATSTE000M	Catenacciolo intermedio di sicurezza per stecca in alluminio e/o acciaio da 15 cm montato		Pz
CATSTE060M	da 60 cm montato		
CATSICAVP	Catenacciolo intermedio di sicurezza per avvolgibile in plastica (le asole si quotano a parte)		Pz
CATTER000	Catenacciolo per terminale in alluminio		Pz
CATTER100	da 100 cm		
CATTER160	da 160 cm		

# SERRATURE PER TERMINALE

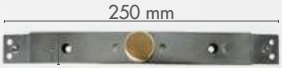
Per avvolgibili in alluminio e acciaio

ARTICOLO	DESCRIZIONE	DISEGNO	UM
SERTERALP	Serratura con pomolo per terminale in alluminio	 <p>250 mm</p>	Pz
SERTERALPM	Serratura con pomolo per terminale in alluminio montata		
SERTERAL	Serratura con chiave per terminale in alluminio	 <p>250 mm</p>	Pz
SERTERALM	Serratura con chiave per terminale in alluminio montata		

Piattina per serratura

ARTICOLO	DESCRIZIONE	DISEGNO	UM
PIASEARCH	Piattina 12x3 mm per serratura		Pz

ARTICOLO	DESCRIZIONE	DISEGNO	UM
RINFTERALL	Rinforzo per Terminale		ml

# SPILLATRICE AD ARIA COMPRESSA

ARTICOLO	DESCRIZIONE	COLORE	DISEGNO	UM
CUCITOMER99 16	Cucitrice Omer 99 16	verde		Pz.

# PUNTI PER SPILLATRICE

ARTICOLO	DESCRIZIONE	DISEGNO	UM
PUNTI 99/04	Punti a graffetta 99/04 per profilo L08		1 confezione
PUNTI 99/05	Punti a graffetta 99/05 per profilo L09		1 confezione
PUNTI 99/06	Punti a graffetta 99/06 per i profili L14, L15		1 confezione
PUNTI 40/06	Punti a graffetta 40/06 per profilo C09		1 confezione
PUNTI 40/08	Punti a graffetta 40/08 per i profili L14, C12		1 confezione

# CINTINI E RULLINI DI RINVIO

ARTICOLO	DESCRIZIONE	DISEGNO	UM
CINTY40	Cintino Asolato Nylon 40 cm		Pz (confezione 2500 pz)
CINTY	Cintino in Nylon 20mm		Rotolo da 50m
CINCO	Cintino cotone		Rotolo da 50m
CINTY 20x12	Cintino 20x12mm		Rotolo da 50m
CINTY14X12	Cintino 14x12mm		Rotolo da 50m
RULRINVIO	Rullino di rinvio medio		Pz
RULRINV33R	Rullino di rinvio registrabile 33 mm		Pz



# GANCI DI ATTACCO AL RULLO, MOLLE DI SICUREZZA

Per avvolgibili in alluminio e acciaio

ARTICOLO	DESCRIZIONE	DISEGNO	UM
MOLLAMAX	Molla di sicurezza Max per avvolgibile	 100mm 200mm	Pz
MOLLAMIG	Molla di sicurezza Mignon per avvolgibile	 100mm 136mm	Pz
MOLLAMAXPRO	Copri molla Max	 60,20mm 135mm	Pz
GANASOFER	Gancio antitaglio per avvolgibili	 30mm 100mm	Pz
AVVEBLOC3	Euroblock a 3 elementi per stecca 14 mm		Pz
AVVEBLOC3L	Euroblock a 3 elementi per stecca 14 mm per Lupin		Pz
AVVADA3BL	Anello adattatore euroblock per rullo da Ø 60		Pz
AVVADA5BL	Anello adattatore euroblock per rullo da Ø 70		Pz
AVVADA3BLM	Anello adattatore euroblock per rullo da Ø 60 per stecca 9 mm Per profili L09, C09, C12 per serrande		Pz
AVVADA3BLL	Anello adattatore per Euroblock Lupin		Pz
AVVEBLOC3M	Euroblock per rullo Ø 60 a 3 elementi per stecca stecca alluminio mignon e acciaio. Per profili L09, C09, C12 per serranda		Pz
GANATRU	Ganci attacco rullo	 40mm 40mm	Pz
GRAPFER	Grappa fermacintino zincata		Pz
GANPVCUNI	Attacco cintino in PVC Universale		Pz
GANCETTIATRU	Gancetti per attacco a rullo	 33,80mm 14,30mm	Pz

# ACCESSORI E CASSETTE

Per avvolgibili in pvc, alluminio e acciaio

ARTICOLO	DESCRIZIONE	DISEGNO	UM
CAS185NOR06	Cassetta in plastica per avvolgitore semincassato mt 6 int. 185mm		Pz
CAS165NOR46	Cassetta in plastica 4 / 6 mt int. 165 mm		Pz
CAS185NOR10	Cassetta in plastica 10/12 mt int. 185 mm		Pz
CAS165NOR12	Cassetta in plastica 1.2 mt int. 165 mm		Pz
CAS185NOR08	Cassetta PVC 8 mt int. 185 mm		Pz







# ACCESSORI E AVVOLGITORI

Per avvolgibili in pvc, alluminio e acciaio

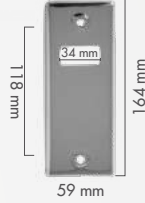
ARTICOLO	DESCRIZIONE	DISEGNO	UM
AVV115NOR06	Avvolgitore 6 mt - int. 115mm		Pz
AVV128NOR06	Avvolgitore 6 mt - int. 125 mm		Pz
AVV145NOR06	Avvolgitore 6 mt - int. 145 mm		Pz
AVV165NOR06	Avvolgitore da 6 mt - int. 165 mm		Pz
AVV165NOR12	Avvolgitore da 12 mt - int. 165 mm		Pz
AVV185NOR06	Avvolgitore da 6 mt - int. 185mm		Pz
AVV185NOR12	Avvolgitore da 12 mt - int. 185 mm		Pz
AVV210NOR06	Avvolgitore da 6 mt - int. 205 mm		Pz
AVV210NOR12	Avvolgitore da 12 mt - int. 205 mm		Pz
AVV255NOR12	Avvolgitore 12 mt - int. 255mm		Pz
AVVSMA165C5N AVVSMA165C5B	Avvolgitore Small semi da 155 mm con cintino, cassetta e placca nera Avvolgitore Small semi da 155 mm con cintino, cassetta e placca bianca		Pz
MINAVSHELL06B MINAVSHELL06M	Avvolgitore tipo Shell da 6 mt con cintino da 14x1,2 mm, cassetta e placca colore bianco colore marrone		Pz
AVV165SEM06	Avvolgitore Semincassato zincato mt.6 int.165 mm		Pz
AVVCLIK012 AVVUNIO6KLI	Avvolgitore universale Kliko 12 mt mt. 6 l. 142 - 165 - 185		Pz

# ACCESSORI E CASSETTE

per avvolgibili in plastica, alluminio e acciaio

ARTICOLO	DESCRIZIONE	DISEGNO	UM
PLA115INOX6	Placca per avvolgitore interasse 115mm		Pz
PLA125INOX6	Placca per avvolgitore int. 125 mm		Pz
PLA145INOX6	Placca per avvolgitore int. 145mm		Pz
PLASEMACC06	Placca per avvolgitore int. 165 mm semincasso nera		Pz
PLASEMALL06	Placca per avvolgitore int. 165 mm semincasso argento		Pz
PLAASSE165B	Placca per avvolgitore int. 165 mm semincasso bianco		Pz
PLAAC4/6/12	Placca inox per avvolgitore mt 4/6/8/12, int. 165 mm		Pz

# ACCESSORI E CASSETTE

per avvolgibili in plastica, alluminio e acciaio

ARTICOLO	DESCRIZIONE	DISEGNO	UM
PLA185ACC06	Placca inox per avvolgitore mt 6/8/12, int. 185 mm		Pz
PLA205INOX6	Placca inox da 205 mm		Pz
PLA255INOX12	Placca per avvolgitore int. 255mm		Pz
PLAPVCORO	Placca in pvc per Kiklo color oro		Pz
PLAPVCAVO	Placca in pvc per Kiklo color avorio		Pz
PLAPVCBIA	Placca in pvc per Kiklo color bianco		Pz.
PLAPVCNER	Placca in pvc per Kiklo color nero		Pz.
PLAPVCARG	Placca in PVC per Kiklo color argento		Pz.

# ACCESSORI E AVVOLGITORI

Per avvolgibili in plastica, alluminio e acciaio

ARTICOLO	DESCRIZIONE	DISEGNO	UM
AVV000CAS06D AVV000CAS06S	Avvolgitore a cassonetto completo destro sinistro		Pz.
BLOFERAVVCA	Blocca cintino zincato per avvolgitore a cassonetto.		Pz.
RIDFERPUL22 RIDFERPUL24	Riduttore con supporto Ø 22 Riduttore con supporto Ø 24		Pz.
RIDCOMP22	Riduttore completo: staffa, cassetta e avvolgitore Ø 22		Pz.
SUPRID000	Supporto a murare per riduttore		Pz.
AVV000FRI00D AVV000FRI00S	Avvolgitore a frizione destro sinistro		Pz.
AVVCORDFRIZ	Cordone per avvolgitore a frizione		Pz.
AVVGUICOFRI	Guida cordone per avvolgitore a frizione		Pz.
CALAVVFRI00	Calotta per avvolgitore a frizione		Pz.

# PULEGGE IN PLASTICA E ZINCATE

ARTICOLO	DESCRIZIONE	DISEGNO	UM
PULNORPVC18 PULNORPVC20 PULNORPVC22	Puleggia in plastica per rullo da 60 perno esterno Ø 18 cm Ø 20 cm Ø 22 cm		Pz
PULINCPVC18 PULINCPVC20 PULINCPVC22	Puleggia in plastica per rullo da 60 perno interno Ø 18 cm Ø 20 cm Ø 22 cm		Pz
PULR40FER14 PULR40FER18 PULR40FER22	Puleggia in ferro per rullo da 40 - Ø14 cm per rullo da 40 - Ø18 cm per rullo da 40 - Ø22 cm		Pz
PULARGFER16 PULARGFER19 PULARGFER21 PULARGRIN21	Puleggia in ferro per argano per rullo da 60 - Ø 16 cm per rullo da 60 - Ø 19 cm per rullo da 60 - Ø 21 cm per rullo da 60 Ø - 21 cm rinforzata		Pz
PULPASFER18 PULPASFER20 PULPASFER22	Puleggia passante in ferro da 18 cm da 20 cm da 22 cm		Pz
PULNORFER18 PULNORFER20 PULNORFER22 PULNORFER24	Puleggia in ferro per rullo da 60 perno esterno Ø 18 cm Ø 20 cm Ø 22 cm Ø 24 cm		Pz

# CALOTTE IN PLASTICA E ZINCATE

ARTICOLO	DESCRIZIONE	DISEGNO	UM
CALRINFER60 CALRINFER70	Calotta rinforzata in ferro per rullo 60 per rullo 70		Pz
CALREGFER60 CALREGFER70	Calotta registrabile in ferro per rullo 60 per rullo 70		Pz
CALNORFER40 CALNORFER60 CALNORFER70	Calotta in ferro per rullo da 40 per rullo da 60 per rullo da 70		Pz
CALDOPFER60 CALDOPFER70	Calotta doppia in ferro per rullo 60 per rullo 70		Pz
CALNORPVC60	Calotta in plastica per rullo da 60		Pz
CALRINPVC60	Calotta registrabile e rinforzata in plastica per rullo da 60		Pz
CALRINPVC70	Calotta registrabile e rinforzata in plastica per rullo da 70		Pz







## SUPPORTI E CUSCINETTI ZINCATI

ARTICOLO	DESCRIZIONE	DISEGNO	UM
SUPSELEG	Supporto a sfera a murare zincato leggero con cuscinetto		Pz
CUSIMB42BF	Cuscinetto per sup. pes. D42 Bocc. ferro		Pz
SUPSPES/C	Supporto a sfera a murare pesante zincato, senza cuscinetto		Pz
SUPCASS/C	Supporto a cassonetto senza cuscinetto piega 11		Pz
CUSSUPCAST	Supporto a cassonetto senza cuscinetto Piega 11 tondo		Pz
SUPCASPES/SC	Supporto a cassonetto pesante senza cuscinetto		Pz
CUSIMB42BF	Cuscinetto per sup. pes. D42 Bocc. ferro		Pz
CUSSUPCAST	Cuscinetto a cassonetto legno s/c piega 11		Pz
SUPREGPES	Supporto pesante registrabile con vite		Pz
CUSIMB42BF	Cuscinetto per sup. pes. D42 Bocc. ferro.		Pz
SUPCAS090	Supporto a cassonetto mm 90 dentro cuscinetto da 40mm		Pz
SUPCAS035	Supporto a cassonetto mm35		Pz
SUPCAS080	Supporto a cassonetto mm80		Pz
SUPOME000	Supporto OMEGA DX/SX zincato		Pz
SUPBIF000	Supporto bifora completo con cuscinetto		Pz

# SUPPORTI E CUSCINETTI ZINCATI

ARTICOLO	DESCRIZIONE	DISEGNO	UM
SUPSEZ000	Supporto a murare per cuscinetto estraibile		Pz
CUSSUPCAS	Cuscinetto quadrato per supporto a cassonetto piega 11	 43,80 mm 17,85 mm 17,85 mm 43 mm	Pz
CUSSUPCAST	Cuscinetto tondo per supporto a cassonetto	 39,5 mm 15,28 mm 41,74 mm	Pz
CUSSFELEG	Cuscinetto per supporto a sfera leggero	 44,6 mm 74,4 mm 34,1 mm	Pz
CUSSFELEGFM	Cuscinetto femmina per supporto a sfera leggero.		Pz
CUSIMB42BN	Cuscinetto a sfera Ø 40/42 con boccola nylon	 12 mm 28 mm 42 mm	Pz
CUSIMB42BF	Cuscinetto a sfera Ø 42 con boccola ferro		Pz
CUSIMB40BF	Cuscinetto a sfera Ø 40 con boccola ferro		Pz









# SUPPORTI VERCELLI E SUPPORTI A SQUADRA

ARTICOLO	DESCRIZIONE	DISEGNO	UM
BANSUPSQU40	Bandierina con cuscinetto per supporto a squadra e Vercelli 40		Pz
SUPVER030M40	Supporto Vercelli piega 30 da 40 mm		Pz
SUPVER030M50	piega 30 da 50 mm		
SUPVER80M40	piega 80 da 40 mm		
SUPVER080M40	piega 80 da 50 mm		
SUPVER080M50	piega 100 da 50 mm		
SUPVERC040	Coppia Vercelli piega 30/80 da 40 mm		Coppia
SUPVERC050	piega 30/80 da 50 mm		
SUPVERC100	piega 30/100 da 50 mm		
SUPSQU040	Staffa a squadra da 40 mm completo		Pz











# RULLI OTTAGONALI ZINCATI E PROLUNGA

ARTICOLO	DESCRIZIONE	TIPOLOGIA	DISEGNO	UM
RU406BA RU406SM	Rullo zincato da 40 - 6\10 da 40 - 6\10	in barre da 6 mt su misura		MI
RU606BA RU606SM RU610BA RU610SM	Rullo zincato da 60 - 6\10 da 60 - 6\10 da 60 - 10\10 da 60 - 10\10	in barre da 6 mt su misura in barre da 6 mt su misura		MI
RU711BA RU711SM	Rullo zincato da 70 - 11\10 da 70 - 11\10	in barre da 6 mt su misura		MI
RULPROFER35 RULPROFER50	Prolunga telescopica con calotta 35 cm con calotta 50 cm			Pz









# GUIDACINGHIE ZINCATE E IN PLASTICA

ARTICOLO	DESCRIZIONE	DISEGNO	UM
GUIVER2RPVC	Guidacinghia verticale con 2 rullini in plastica		Pz
GUITRA2RPVC	Guidacinghia trasversale a 2 rullini		Pz
GUIVER2RFER	Guidacinghia verticale con 2 rullini in ferro nichelati		Pz
GUITRA2RFGR	Guidacinghia trasversale a due rullini zincato		Pz
GUIVER3RPVC	Guidacinghia verticale a tre rullini in pvc zincato	 60 mm 45 mm 114 mm	Pz
GUITRANYLONB	Guidacinghia orientabile con spazzolino Bianco		Pz
GUITRANYLONM	Guidacinghia orientabile con spazzolino Grigio		Pz
GUITRANYLONM	Guidacinghia orientabile con spazzolino Marrone		Pz
GUITRANYLONA	Guidacinghia orientabile con spazzolino Avorio		Pz

# GUIDACINGHIE ZINCATE

ARTICOLO	DESCRIZIONE	DISEGNO	UM
GUITRANYSM	Guidacinghia trasversali in nylon con spazzolino marrone		Pz
GUITRANYSB	Guidacinghia trasversali in nylon con spazzolino bianco		Pz
GUIRENOB	Guidacinghia orizzontale in nylon bianco		Pz
GUIRENO	Guidacinghia orizzontale in nylon nero		Pz
GUIRETNOM	Guidacinghia orizzontale i in nylon marrone		Pz
GUIRETNYSM	Guidacinghia verticale Marrone con spazzolino		Pz
GUIRETNYSB	Guida cinghia verticale bianca con spazzolino		Pz
GUIRETNYN	Guidacinghia verticale in nylon nero		Pz
GUIRETNYM	Guidacinghia verticale in nylon marrone		Pz
GUIRETNBY	Guidacinghia verticale in nylon bianco		Pz
CASPREGCI	Guidacinghia in nylon per cassetto		Pz

# ARGANI A FUNE

ARTICOLO	DESCRIZIONE	DISEGNO	UM
ARGO50ALL	Argano 50 Kg completo di meccanismo, cassetta, snodo, tubo, fune, placca e manovella		Pz
ARG100ALL	Argano 100 Kg completo di meccanismo, cassetta, snodo, tubo, fune, placca e manovella		Pz
MECARG050	Meccanismo arganello 50 Kg		Pz
MECARG100	Meccanismo arganello 100 Kg		Pz
CASPLARG050	Cassetta per arganello 50 Kg		Pz
CASPLARG100	Cassetta per arganello 100 Kg		Pz
PLAALLARG50	Placca per arganello 50 Kg		Pz
PLAALLAR100	Placca per arganello 100 Kg		Pz
CORACARG050	Cordina in acciaio da 2,5 mm per arganello 50 Kg da 6 mt, disponibile in rotolo da 100 mt		Pz
CORACARG100	Cordina in acciaio da 3 mm per arganello 100 Kg da 6 mt, disponibile in rotolo da 100 mt		Pz
MANARG050	Manovella per arganello da 50Kg.		Pz
MANARG100	Manovella per arganello da 100 Kg		Pz
TUBPVCARG	Tubicino in pvc per arganello		Pz
SNONORARG	Snodo per arganello		Pz

# ARGANI BGM 50





ARTICOLO	DESCRIZIONE	DISEGNO	UM
ARGBGM050	Argano BGM 50 Kg completo di meccanismo, cassetta, tubo, placca e manovella		Pz
ARGBGM100C	Argano BGM 100Kg. Completo di meccanismo, cassetta, placca, manovella e tubo		Pz
MECBGM050	Meccanismo arganello BGM 50 Kg		Pz
MECBGM100	Meccanismo arganello BGM 100 Kg		Pz
PLAARBGM50	Placca per arganello BGM 50 Kg		Pz
PLAARBGM100	Placca per arganello BGM 100 Kg		Pz
CASALBGM050	Cassetta per arganello BGM 50 Kg		Pz
CASALBGM100	Cassetta per arganello BGM 100 Kg		Pz
MANARGBGM50	Manovella per arganello BGM da 50 Kg		Pz
MANARGBGM100	Manovella per arganello BGM da 100 Kg		Pz
TUBPVCARG	Tubicino in pvc per arganello		Pz







# ARGANI SYDNEY

ARTICOLO	DESCRIZIONE	DISEGNO	UM
ARGSYD25C	Argano SYDNEY portata 25 Kg completo di innesto, calotta, snodo, asta e fermoasta		Pz
ARGSYD34C	Argano SYDNEY portata 34 Kg completo di innesto, calotta, snodo, asta e fermoasta		Pz
MINCALPL40	Calotta in pvc foro quadro 13 mm per argano SYDNEY Ø 40		Pz
MINCALPL60	Calotta in pvc foro quadro 13mm per argano SYDNEY Ø 60		Pz
MINARGSNOD45	Snodo per argano SYDNEY		Pz
FERNYLARGB	Fermoasta in nylon per argano SIDNEY e asta oscillante bianco		Pz
MININNARGSYD	Innesto esagonale per argano SYDNEY		Pz
ASTARGANO	Asta per argano colore bianco, lunghezza 154 cm		Pz
MINARSY25F19	Argano SYDNEY portata 25 Kg solo meccanico		PZ
MINARSY34F19	Argano SYDNEY portata 34 Kg solo meccanico		PZ

# ARGANI AD ASTA OSCILLANTE E ACCESSORI

ARTICOLO	DESCRIZIONE	TIPOLOGIA	DISEGNO	Um
ARGOSCO20C	Argano ad asta oscillante completo con snodo flessibile	Portata da 20 Kg		Pz
ARGOSCO30C	Argano ad asta oscillante completo con snodo flessibile	Portata da 30 Kg		Pz
ARGOSCO60C	Argano ad asta oscillante completo con snodo flessibile	Portata da 60 Kg		Pz
ARGOSCA20C	Argano ad asta oscillante completo con snodo cardanico	Portata da 20 Kg		Pz
ARGOSCA30C	Argano ad asta oscillante completo con snodo cardanico	Portata da 30 Kg		Pz
ARGOSCA60C	Argano ad asta oscillante completo con snodo cardanico	Portata da 60 Kg		Pz
ARGOSCFLANG	Flangia supporto per argano ad asta oscillante			Pz
MOTOCCSNO	Occhiolo per snodo			Pz
ARGOSCBCOC	Boccola di collegamento tra argano e snodo cardanico			Pz

# SNODI, GIUNTI E PERNI

ARTICOLO	DESCRIZIONE	DISEGNO	UM
ARGSNOAST	Snodo cardanico con astina esagonale		Pz
SNOCARARG	Snodo cardanico con astina esagonale verticale 35°		Pz
SNOFLEARG	Giunto flessibile per argano ad asta oscillante		Pz
ARGIUNTFLES	Giunto flessibile a 35° per argano ad asta oscillante		Pz
ARGOSBCOC	Boccola di collegamento tra argano e snodo cardanico		Pz
MINICALD40Q10	Calotta in pvc per argano ad asta oscillante per rullo Ø 40 -10 mm		Pz
MINICALD60Q10	Ø 60 -10 mm		
MINICALD60Q15	Ø 60 -15 mm		
APALLLL	Apparecchio a sporgere in alluminio col. Argento o Bronzo LEVA LATERALE (1)		Pz
APALLAC	Apparecchio a sporgere tutto in alluminio col. Argento o Bronzo ATTACCO CONTRARIO (2)		Pz
APALLLC	Apparecchio a sporgere tutto in alluminio col. Argento o Bronzo LEVA CENTRALE (1)		Pz
APALLLL	Apparecchio a sporgere in alluminio col. RAL 9010 / 1013 / 8017 LEVA LATERALE (1)		Pz
APALLAC	Apparecchio a sporgere tutto in alluminio in ferro col. RAL 9010 / 1013 / 8017 ATTACCO CONTRARIO (2)		Pz
APALLLC	Apparecchio a sporgere tutto in alluminio col. RAL 9010 / 1013 / 8017 LEVA CENTRALE (1)		Pz
APFERLL	Apparecchio a sporgere in FERRO zincato LEVA LATERALE (1)		Pz
APFERAC	Apparecchio a sporgere in FERRO zincato ATTACCO CONTRARIO (2)		Pz
APFERLC	Apparecchio a sporgere in FERRO zincato LEVA CENTRALE (1)		Pz

# APPARECCHI A SPORGERE IN FERRO E IN ALLUMINIO

## SCHEMA TELAIO A SPORGERE STANDARD IN ALLUMINIO

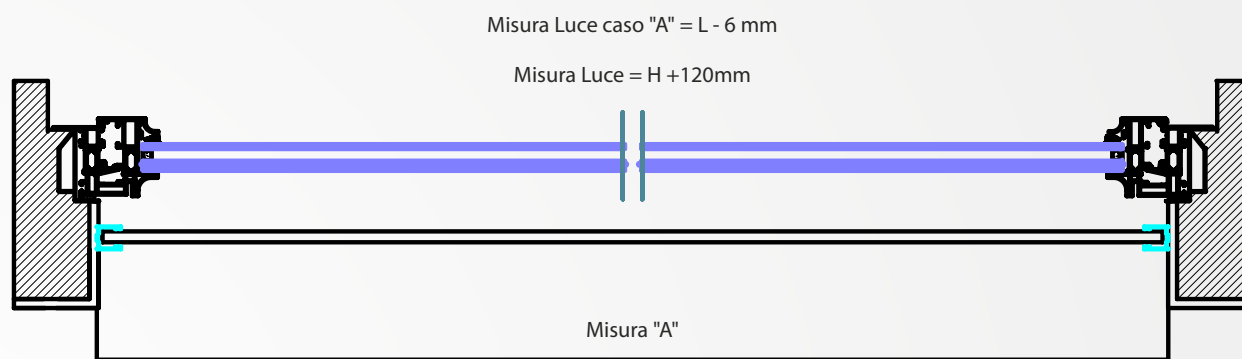

ATTENZIONE: PRECISA SEMPRE LA MISURA "A"

## SCHEMA TELAIO A SPORGERE ATTACCO AL CONTRARIO

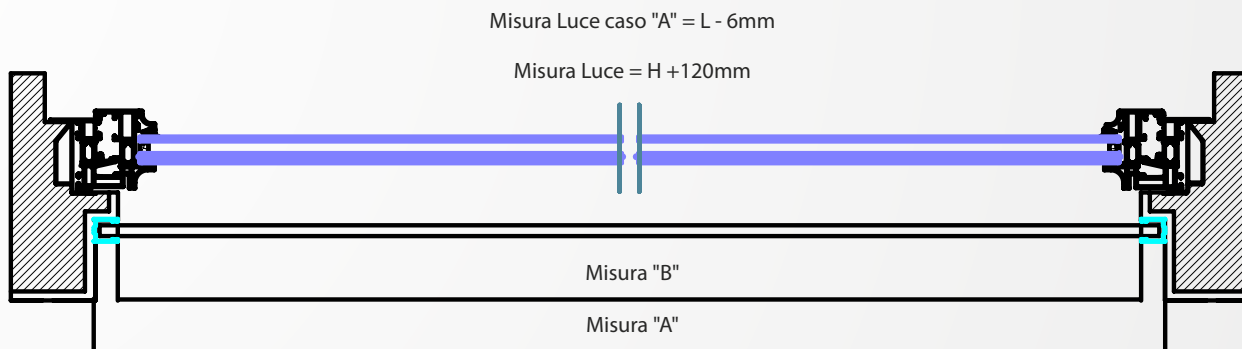

ATTENZIONE: PRECISA SEMPRE LA MISURA "A" E "B"

# SCHEMI DI MONTAGGIO

## LEVA LATERALE FERRO ZINCATO E ALLUMINIO

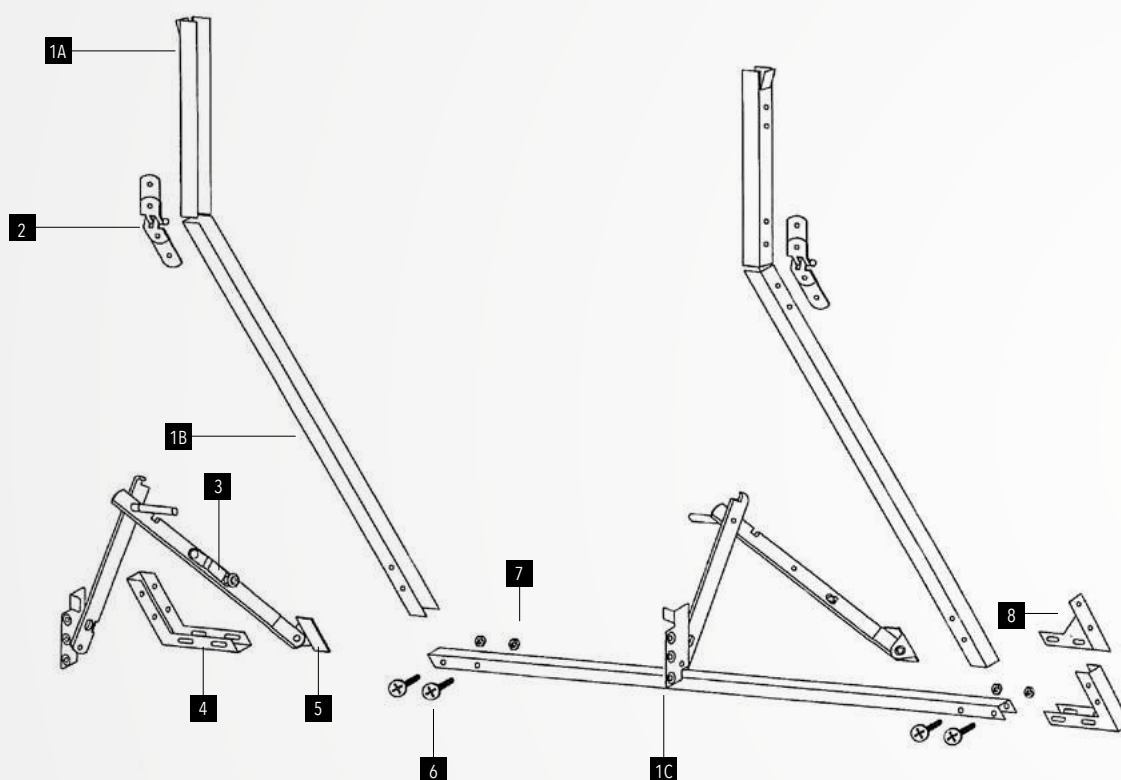

**1A** Guida parte fissa

**1B** Guida parte mobile

**1C** Ferro a "U"

**2** Cerniera

**3** Braccio per leva laterale

**5** Angolo di rinforzo a "u"

**5** Angolo di ancoraggio

**6** Viti

**7** Dadi

**8** Angolo di rinforzo

## LEVA CENTRALE FERRO ZINCATO E ALLUMINIO

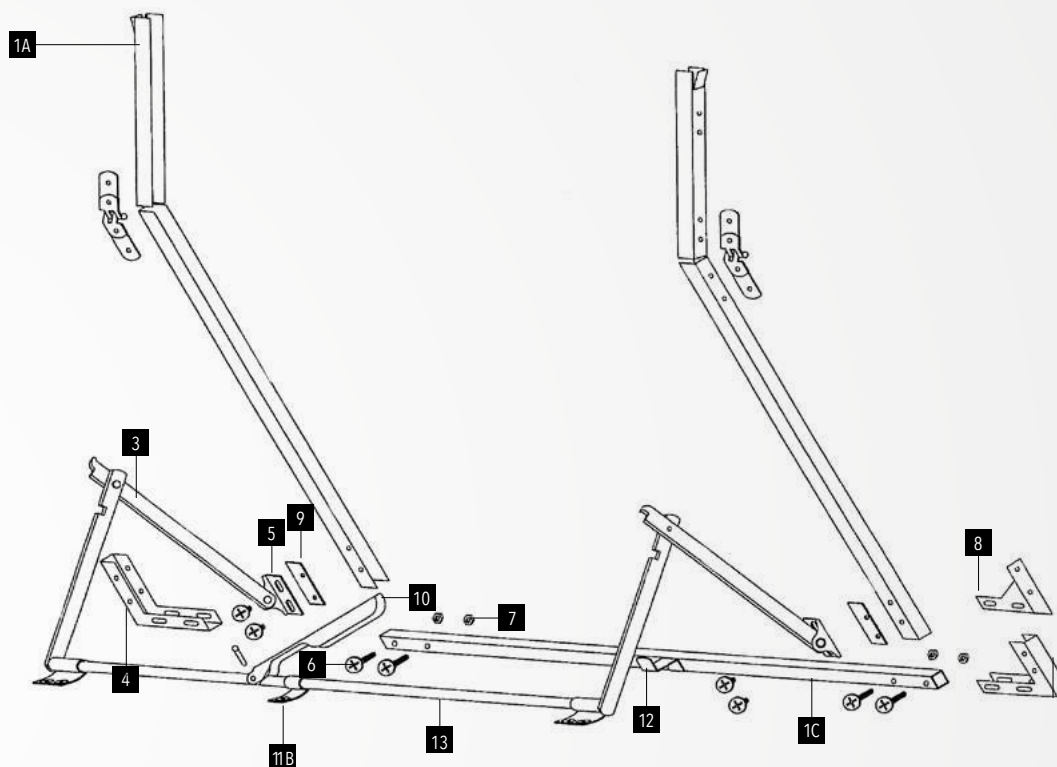

**1A** Guida parte fissa

**1B** Guida parte mobile

**1C** Ferro a "U"

**2** Cerniera

**3** Braccio per leva laterale

**4** Angolo di rinforzo a "u"

**5** Angolo di ancoraggio

**6** Viti

**7** Dadi

**8** Angolo di rinforzo

**9** Piastrina filettata

**10** Maniglia centrale

**11A** Occhio con 2 fori

**11B** Occhio con 1 foro

**12** Linguetta

**13** Tondino